



**Allgemeine Sicherheitshinweise**  
General safety notes



- \* Montage / Wartung nur durch Fachkräfte.
- \* Bei Instandsetzung / Instandhaltung nur Originalteile verwenden.
- \* Werden nachträglich Änderungen an Leuchten vorgenommen, so gilt derjenige als Hersteller, der diese Änderung vornimmt.
- \* Der Hersteller übernimmt keine Haftung für Schäden, die durch unsachgemäßen Einsatz entstehen.



- \* Installation / maintenance only by skilled personnel.
- \* During overhaul / maintenance only use original parts.
- \* If any luminaire is subsequently modified, the person responsible for the modification shall be considered the manufacturer.
- \* The manufacturer bears no liability for damage caused by inappropriate use or application.



- \* Les opérations d'installation et d'entretien doivent être effectuées exclusivement par des personnes qualifiées.
- \* Dans le cas d'une remise en état, utiliser uniquement des composants d'origine.
- \* Toutes modifications apportées au luminaire se feront sous la responsabilité exclusive de celui qui les effectue.
- \* Le fabricant décline toute responsabilité résultant d'une mise en oeuvre inappropriée du produit.



- \* El montaje y mantenimiento lo efectuaran únicamente los técnicos especializados.
- \* Para reparaciones han de emplearse solo piezas originales de recambio.
- \* Reservado el derecho de modificación de dimensiones, pesos y características técnicas, sin previo aviso.
- \* El fabricante no asume responsabilidad por modificaciones realizadas por terceros, ni por instalación incorrecta.



- \* Montaggio / Manutenzione solo per mezzo di Personale specializzato.
- \* Per Riparazione / Manutenzione impiegare solo Parti originali.
- \* Il costruttore si riserva il diritto di apportare senza preavviso modifiche di peso, dimensioni e caratteristiche tecniche.
- \* Il costruttore non è responsabile per danni derivanti da modifiche realizzate da terzi e da una installazione non corretta.



- \* Montagem/Manutenção efectuada unicamente por pessoal técnico especializado.
- \* Utilizar somente peças originais do fabricante.
- \* O fabricante não se responsabiliza por danos resultantes da inadequada utilização dos materiais.



- \* A szerelés / karbantartást csak szakszemélyzet végezheti
- \* Üzembehelyezésnél / karbantartásnál csak eredeti alkatrészek használhatók.



- \* Τοποθέτηση / Συντήρηση μόνο από ηλεκτρολόγο
- \* Κατά την επισκευή / διατήρηση χρησιμοποιείτε γνήσια ανταλλακτικά μόνο



- \* Montage / service alleen door vakkundig personeel.
- \* Bij inbedrijfstellen / onderhoud alleen originele onderdelen gebruiken.



- \* Monteres kun av fagpersonell.
- \* Ved feilretting : Bruk kun originaldeler.



- \* Montering akötsel endaat av fackfolk.
- \* Använd bara originaldelar vid igångsättning / underhall.



- \* при ремонте применять только те же самые части.
- \* Монтаж / обслуживание только специалистами.



- \* Montáž a údržba máu e být prováděna výhradně odbornou pracovní silou.
- \* Při údržbě nebo opravě musí být pou ity jen originální náhradní díly.



- \* Montaj ve Bakim sadece yetkili personel tarafindan yapilmalidir.
- \* Bakimda sadece orjinal parcalar kullanimalidir.



- \* Montaż / konserwacja tylko przez fachowy personal.
- \* Dla naprawy / bieżącej eksploatacji stosować tylko oryginalne części zamienne.



- \* Monta o/vzdrževanje lahko izvrši le ustrezno usposobljena oseba.
- \* Pri popravilu/vzdrževalnih delih se lahko uporabljajo samo originalni deli.
- \* V kolikor se na svetilkah naknadno izvedejo spremembe, se za proizvajalca svetilke smatra tisti, ki je izvedel spremembo.
- \* Proizvajalec ne jamči i za škodo, ki bi nastala zaradi nepravilne uporabe.



- \* Monta u/održavanje mora vršiti odgovarajuće osposobljena osoba.
- \* Pri popravku/održavanju koristiti samo originalne dijelove.
- \* Ukoliko se na svjetiljkama naknadno vrše promjene, za proizvođača svjetiljke se smatra taj koji je promjene izvršio.
- \* Proizvođač ne garantuje za štetu koja bi mogla nastati usled nepravilne upotrebe.



- \* Monta u/održavanje mo e da obavi samo stručno osposobljena osoba.
- \* Pri popravljanju/održavanju upotrebljavati samo originalne delove.
- \* Ukoliko se na svetikama naknadno urade izmene, za proizvođača svetilke će se smatrati onaj ko izmene izvrši.
- \* Proizvađač ne garantuje za štetu koja bi mogla nastati usled nepravilne upotrebe.

5LM59102

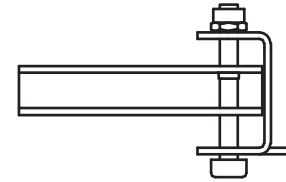

5LM59103

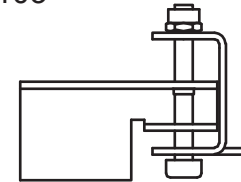

5LM59104

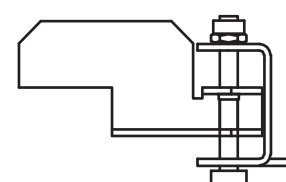

5LM59105

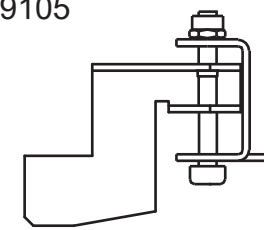

siteco

Siteco GmbH  
Georg-Simon-Ohm-Straße 50  
83301 Traunreut, Germany  
mail: technicalsupport@siteco.de  
Phone: +49 8669 / 33-844  
www.siteco.com

Montage- /  
Betriebsanleitung  
Mounting- /  
Operating instruction

Quadrature®2/  
Quadrature®2  
LED

Einbauzubehör  
recessed accessories

5LM59102  
5LM59103  
5LM59104  
5LM59105

Bestellnr./Order-number: 5MA44-96931  
copyright Siteco  
Änderungen vorbehalten  
af / sam / 17.06.2013

Bitte aufbewahren!  
Please keep for future reference!



T20 [ mm ]

5LM59104

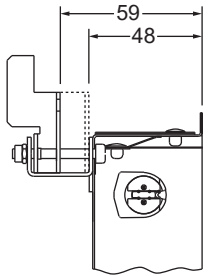
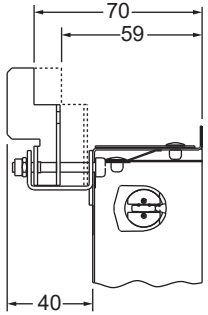

5LM59103

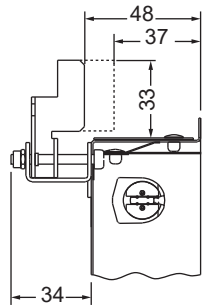

Beispiele  
examples

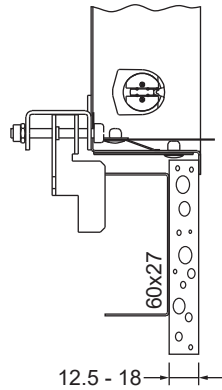
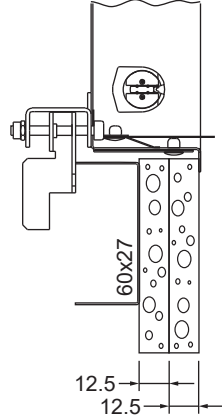
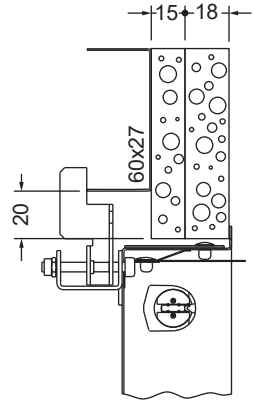

5MQ1.8DL...

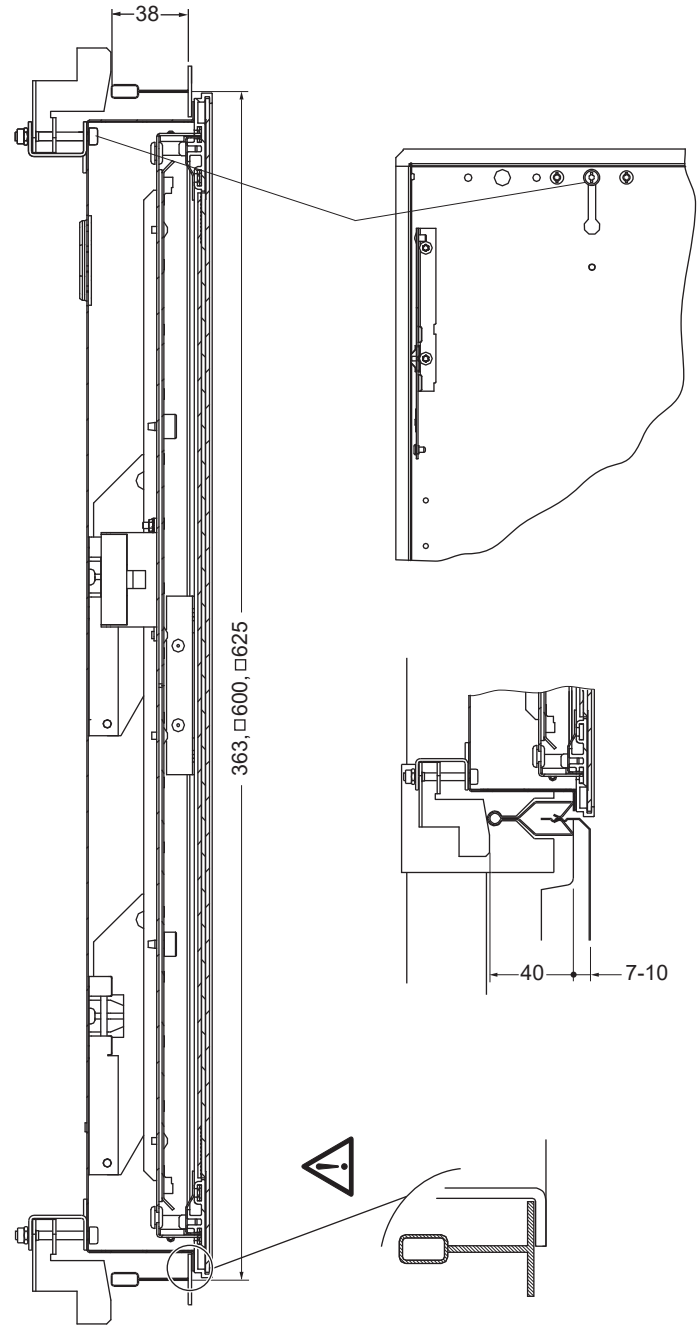

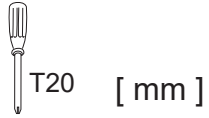

5LM59105  
Quatrature®2 LED

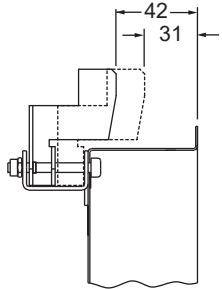

5LM59104

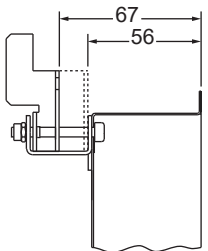
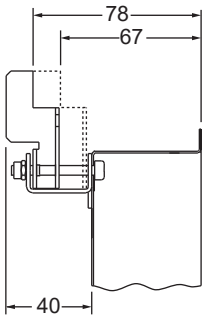

5LM59103

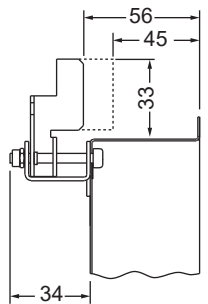

Beispiele  
examples

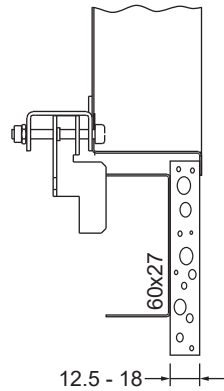
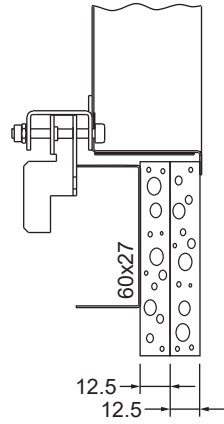
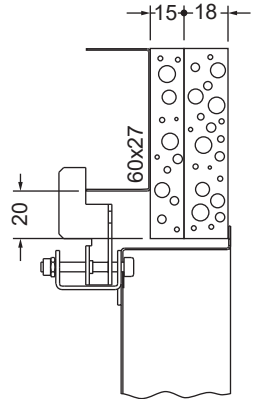

5LM51..2YS/W  
2x24W

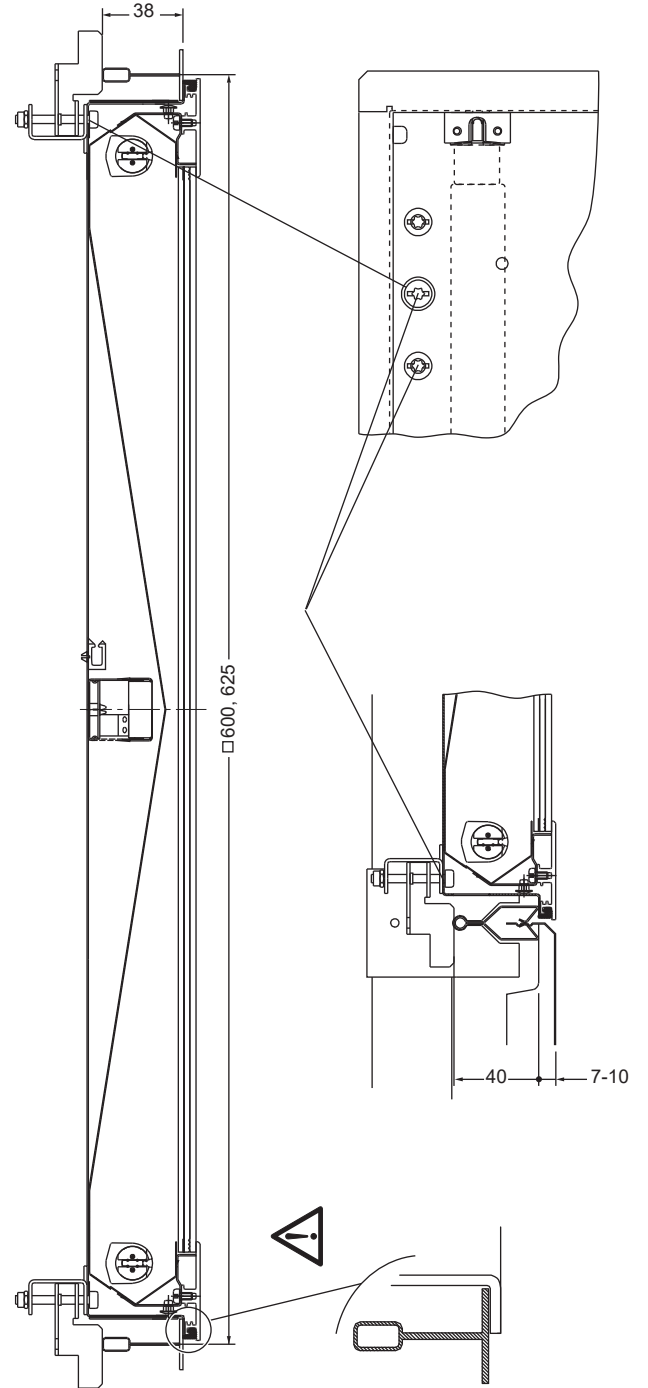

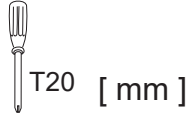

5LM59104

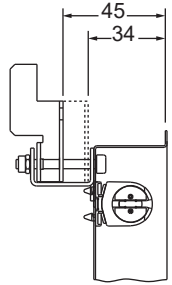
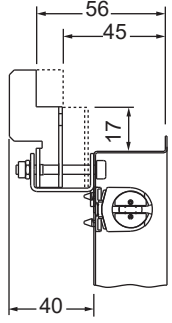

5LM59102

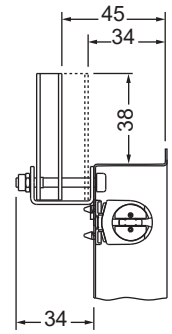

Beispiele  
examples

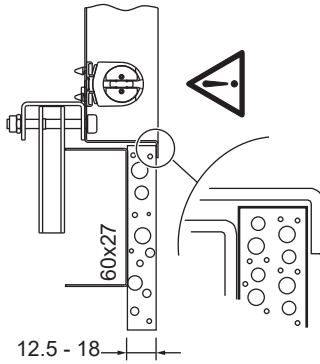
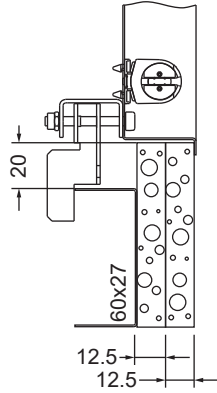
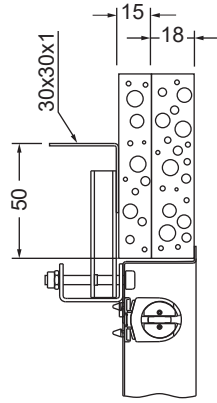

5LM51..2.S/W  
2x8,14,21,28,35W

