

**Order No.:** 5NY513746008 | **GTIN (EAN):** 4058352175088

**Product description:** mast,NEV4,con.rd,alu,coat,DB702S,6m,Ø76



mast, mast, conical round, of aluminium, coated, Siteco® metallic grey (DB 702S), height: 6.0m, spigot size: 76mm (post-top), planted section: h= 1000mm / Ø= 140mm, standard: DIN EN 40, packaging unit: 1 piece

Wt. (kg): 28.3  
 GTIN (EAN): 4058352175088

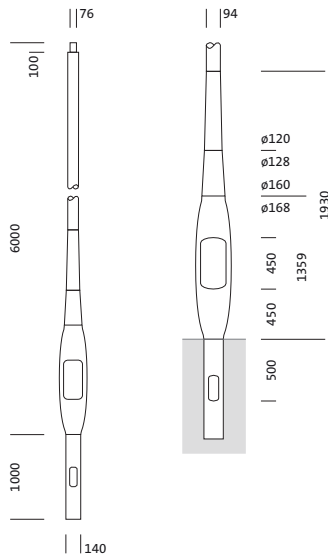

It is mandatory that the assembly instructions must be observed when planning and installing the electrical installation (to be found at [www.siteco.de](http://www.siteco.de))  
 Tolerances related to thermal, electrical and photometric data according to IEC 62722  
 Issued 22.12.2023 - Modifications and errors subject to change - Ensure that you always use the latest version -

Order No.: 5NY513746008 | GTIN (EAN): 4058352175088

Detailed technical description: mast,NEV4,con.rd,alu,coat,DB702S,6m,Ø76



#### Key data

- Product type: mast
- Product name: mast
- Order No.: 5NY513746008

#### Certificates, Standards

- Standard: DIN EN 40

#### Material, Colour

- mast: aluminium, coated, Siteco® metallic grey (DB 702S), conical round, with offset spigot
- Colour specification: Siteco® metallic grey (DB 702S)

#### Dimensions, Weight

- Height: 6.0m
- Weight: 28.3kg
- Mast spigot: spigot size: 76mm
- Planted section: h= 1000mm / Ø= 140mm

Order No.: 5NY513746008 | GTIN (EAN): 4058352175088

Dimensions: mast,NEV4,con.rd,alu,coat,DB702S,6m,Ø76

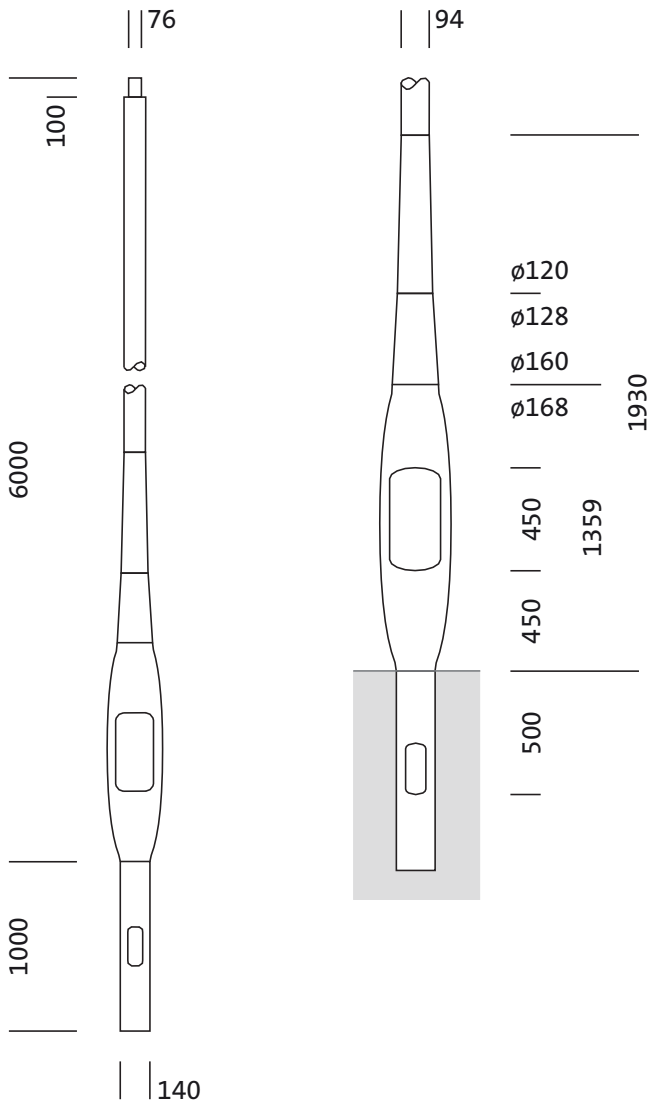

It is mandatory that the assembly instructions must be observed when planning and installing the electrical installation (to be found at [www.siteco.de](http://www.siteco.de))

Tolerances related to thermal, electrical and photometric data according to IEC 62722

Issued 22.12.2023 - Modifications and errors subject to change - Ensure that you always use the latest version -