

Order No.: 51HLA1D14FCA | GTIN (EAN): 4058352321720

Product description: HB11, nrrw, 14060lm840, DA



Highbay 11, LED high bay luminaire, primary light control with lens, of PMMA, light emission: direct distribution, primary light characteristic: symmetric, installation type: surface-mounted, suspended mounting, for 1x 2x LED, rated luminous flux: 14.060lm, luminous efficacy: 173lm/W, light colour: 840, colour temperature: 4000K, control gear: ECG DALI, with terminal, 5-pole, max. 2.5mm², mains connection: 230..240V, AC, 50/60Hz, rated input power: 81W, LED unit, of diecast aluminium, unplated, bead blasted, silver, length: 470mm, width: 500mm, height: 65mm, housing, of diecast aluminium, uncoated, bead blasted, silver, protection rating (complete): IP65, insulation class (complete): insulation class I (protective earthing), certification: CE, ENEC, VDE, UKCA, protection symbol: D, impact resistance: IK08 with glass or PC cover, permissible operating ambient temperature: -35..+55°C, reducing of maximum allowable ambient temperature of 5°C with ceiling mounting, corresponds to IFS (International Featured Standards) requirements for safety and quality in the food industry, packaging unit: 1 piece



Lamps:	1x 2x LED
Wt. (kg):	4.3
GTIN (EAN):	4058352321720

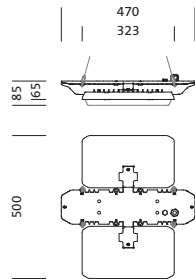

Order No.: 51HLA1D14FCA | GTIN (EAN): 4058352321720

Detailed technical description: HB11,nrrw,14060lm840,DA



Key data

- Product type: LED high bay luminaire
- Product name: Highbay 11
- Order No.: 51HLA1D14FCA

Lighting technology | Lamps | Control gear

Component 1

Lighting technology:

- Light control: lens of PMMA
- Beam angle: narrow distribution
- Symmetry: symmetric
- Light emission: direct distribution
- UGR viewing direction along longitudinal luminaire axis: ≤ 22
- UGR viewing direction along lateral luminaire axis: ≤ 22

Lamps:

- Lamps: with 1x 2x LED
- Rated luminous flux: 14060lm
- Luminous efficacy: 173lm/W
- Colour temperature: 4000K
- Colour rendering index: CRI > 80
- Light colour: 840
- SDCM (Standard Deviation of Colour Matching): MacAdam ≤ 3 SDCM (initial)
- Rated input power: 81W

Operating device:

- Control gear: ECG DALI
- Control: DALI

Certificates, Standards

- Protection rating: IP65
- Insulation class: insulation class I (protective earthing)
- Impact resistance: IK08 with glass or PC cover
- Protection symbol: D
- Temperature range (operation): -35..+55°C
- Supplement: corresponds to IFS (International Featured Standards) requirements for safety and quality in the food industry, reducing of maximum allowable ambient temperature of 5°C with ceiling mounting
- Certification, designation: CE, ENEC, VDE, UKCA

Material, Colour

- LED unit: diecast aluminium, unplated, bead blasted, silver
- Quantity: 2 piece
- Colour specification: silver
- housing: diecast aluminium, uncoated, bead blasted, silver
- Quantity: 1 piece
- Colour specification: silver

Mounting

- Mounting method, mounting location: suspended mounting, surface-mounted, to wire, to the ceiling, to the chain
- Mounting height: 6..20m
- Arrangement: single arrangement
- Supplement: only suitable for indoor use, mounting accessories required, please order separately

Electrical connection

- Connection: terminal, 5-pole, max. 2.5mm²
- Nominal voltage: 230..240V, 50/60Hz, AC

Dimensions, Weight

- Length: 470mm
- Width: 500mm
- Height: 65mm
- Weight: 4.3kg

Service life

- Rated service life: 50000h (L80/B10) at AT = 25°C, 70000h (L85/B50) at AT = ta max, 100000h (L85/B50) at AT = 25°C

Order No.: 51HLA1D14FCA | GTIN (EAN): 4058352321720

Dimensions: HB11,nrrw,14060lm840,DA

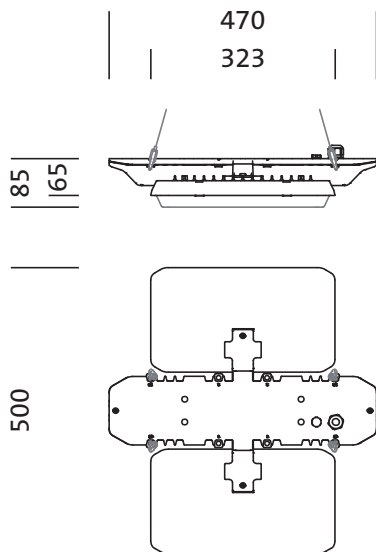

Order No.: 51HLA1D14FCA | GTIN (EAN): 4058352321720

Planning data: HB11,nrrw,14060lm840,DA

51HLA1D14FCA: 1x LED

4058352321720

51HLA1D14FCA

LED 4000 K | CRI ≥ 80 ϕ_N 14060 lm

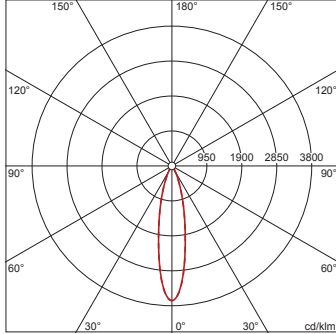

ϕ_{\downarrow} 100% ϕ_{\uparrow} 0%

Luminance values (cd/m²)

	C 0/180	C 90/270
L ₈₀	5430	9184
L ₇₀	11335	8582
L ₆₅	11705	8502

UGR 20.5 20.1

X 4H Y 8H ρ 70/50/20 S 0.25H

51HLA1D14FCA + 59HL91001: 1x LED

4058352321720 + 4058352323519

51HLA1D14FCA + 59HL91001

LED 4000 K | CRI ≥ 80 ϕ_N 13570 lm

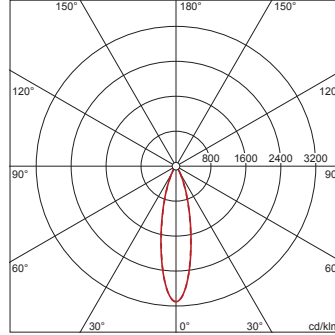

ϕ_{\downarrow} 100% ϕ_{\uparrow} 0%

Luminance values (cd/m²)

	C 0/180	C 90/270
L ₈₀	4538	7689
L ₇₀	12260	10495
L ₆₅	14183	11050

UGR 21.3 20.9

X 4H Y 8H ρ 70/50/20 S 0.25H

51HLA1D14FCA + 59HL91002: 1x LED

4058352321720 + 4058352341650

51HLA1D14FCA + 59HL91002

LED 4000 K | CRI ≥ 80 ϕ_N 12800 lm

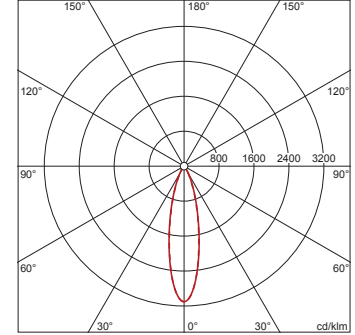

ϕ_{\downarrow} 100% ϕ_{\uparrow} 0%

Luminance values (cd/m²)

	C 0/180	C 90/270
L ₈₀	4281	7253
L ₇₀	11564	9900
L ₆₅	13379	10423

UGR 21.1 20.7

X 4H Y 8H ρ 70/50/20 S 0.25H

Order No.: 51HLA1D14FCA | GTIN (EAN): 4058352321720

Planning data: HB11,nrrw,14060lm840,DA

**51HLA1D14FCA +
59HL91003: 1x LED**

4058352321720 + 4058352341667
51HLA1D14FCA + 59HL91003

LED 4000 K | CRI ≥ 80 ϕ_N 12810 lm

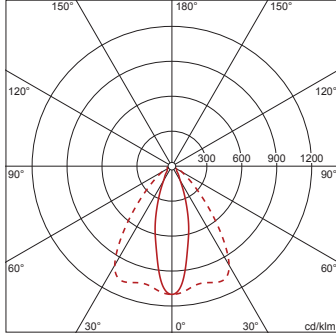

ϕ_{\downarrow} 99% ϕ_{\uparrow} 1%

Luminance values (cd/m²)

	C 0/180	C 90/270
L ₈₀	9066	10613
L ₇₀	7514	16246
L ₆₅	8983	18348

UGR 21.1 25.2

X 4H Y 8H ρ 70/50/20 S 0.25H

**51HLA1D14FCA +
59HL91004: 1x LED**

4058352321720 + 4058352341674
51HLA1D14FCA + 59HL91004

LED 4000 K | CRI ≥ 80 ϕ_N 13040 lm

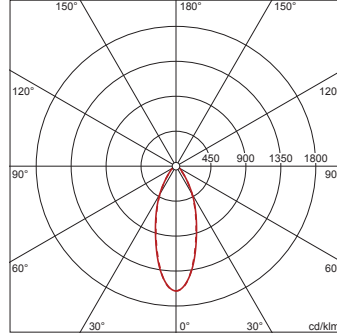

ϕ_{\downarrow} 99% ϕ_{\uparrow} 1%

Luminance values (cd/m²)

	C 0/180	C 90/270
L ₈₀	9250	5857
L ₇₀	8898	8677
L ₆₅	10734	9114

UGR 22 21.1

X 4H Y 8H ρ 70/50/20 S 0.25H