

Order No.: 5MN238DLC003 | GTIN (EAN): 4050737964164

Product description: Vega11,4300lm830,DA

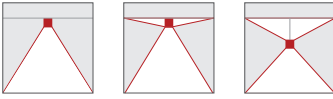

Vega® 11, office luminaire, primary light control with prismatic reflector, of PMMA, transparent prismatic structure, CAT 2 ($L \leq 1500 \text{cd/m}^2$), light emission: direct/indirect distribution, primary light characteristic: symmetric, installation type: suspended mounting, surface-mounted, LED, rated luminous flux: 4.300lm, luminous efficacy: 123lm/W, light colour: 830, colour temperature: 3000K, control gear: ECG, with terminal, 3+2-pole, max. 2.5mm², mains connection: 230V, AC, 50Hz, connection cable inclusive, cable length: 1,5m, rated input power: 35W, luminaire housing, rectangular, rounded, of aluminium section, anodised, metallic grey (RAL 9006), length: 1.250mm, width: 350mm, height: 43mm, luminaire housing, lower part, of aluminium section, anodised, metallic grey (RAL 9006), of PC, grey, protection rating (complete): IP20, insulation class (complete): insulation class I (protective earthing), certification: CE, standard: EN 50419, packaging unit: 1 piece

4050737964164
5MN238DLC003

LED 3000K / CRI \geq 80 Φ_N 4300 lm

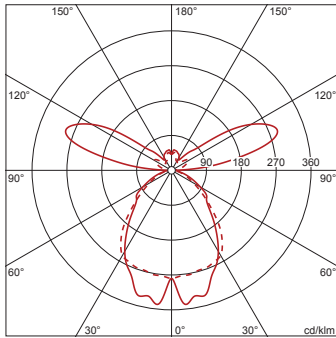

IP 20  

Lamps: LED
Wt. (kg): 6.5
GTIN (EAN): 4050737964164

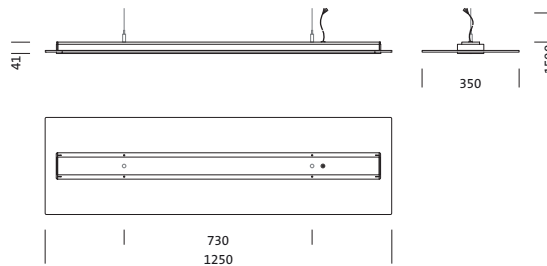

Order No.: 5MN238DLC003 | GTIN (EAN): 4050737964164

Detailed technical description: Vega11,4300lm830,DA



Key data

- Product type: office luminaire
- Product name: Vega® 11
- Order No.: 5MN238DLC003

Lighting technology | Lamps | Control gear

Component 1

Lighting technology:

- Light control: prismatic reflector of PMMA, transparent prismatic structure
- Symmetry: symmetric
- Light emission: direct/indirect distribution, 60:40
- UGR viewing direction along longitudinal luminaire axis: ≤ 16
- UGR viewing direction along lateral luminaire axis: ≤ 16

Lamps:

- Lamps: with LED
- Rated luminous flux: 4300lm
- Luminous efficacy: 123lm/W
- Colour temperature: 3000K
- Colour rendering index: CRI > 80
- Light colour: 830
- SDCM (Standard Deviation of Colour Matching): MacAdam ≤ 3 SDCM (initial)
- Rated input power: 35W

Operating device:

- Control gear: ECG
- Control: DALI

Certificates, Standards

- Protection rating: IP20
- Insulation class: insulation class I (protective earthing)
- Standard: EN 50419
- Certification, designation: CE

Material, Colour

- luminaire housing: aluminium section, anodised, metallic grey (RAL 9006), rectangular, rounded
- Colour specification: metallic grey (RAL 9006)
- luminaire housing, lower part: aluminium section, anodised, metallic grey (RAL 9006)
- Colour specification: metallic grey (RAL 9006)
- Colour specification: grey

Mounting

- Mounting method, mounting location: suspended mounting, surface-mounted
- Arrangement: single arrangement

Electrical connection

- Connection: terminal, 3+2-pole, max. 2.5mm²
- Nominal voltage: 230V, 220..240V, 50Hz, AC
- Connection cable: inclusive, L= 1.5m

Dimensions, Weight

- Length: 1250mm
- Width: 350mm
- Height: 43mm
- Weight: 6.5kg

Service life

- Rated service life: 50000h (L80/B50) at AT = 25°C

Order No.: 5MN238DLC003 | GTIN (EAN): 4050737964164

Dimensions: Vega11,4300lm830,DA

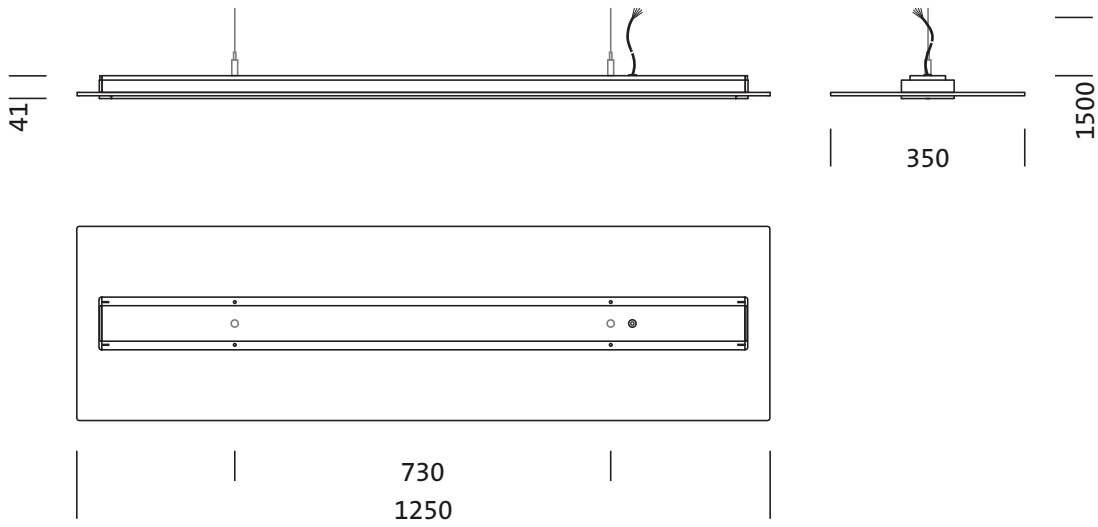

Order No.: 5MN238DLC003 | GTIN (EAN): 4050737964164

Planning data: Vega11,4300lm830,DA

**5MN238DLC003: 1x LED
3000K / CRI ≥ 80**

4050737964164
5MN238DLC003

LED 3000K / CRI ≥ 80 ϕ_N 4300 lm

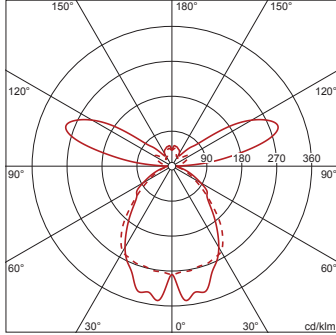

No. of luminaires in room						
Reflection factors 70/50/20						
Em(lx)	100		200		500	
Lh(m)	2.5	3.0	2.5	3.0	2.5	3.0
20 m ²	0.9	1.0	1.7	1.9	4.3	4.8
30 m ²	1.3	1.4	2.5	2.8	6.4	7.0
40 m ²	1.6	1.7	3.1	3.4	7.9	8.6
50 m ²	1.9	2.1	3.8	4.1	9.5	10
75 m ²	2.8	3.0	5.6	5.9	14	15
100 m ²	3.6	3.8	7.2	7.6	18	19
500 m ²	16	16	32	33	80	82

Maintenance factor 0.8 Rh = Lh + 0.5 m

**5MN238DLC003 + 5MN91401:
1x LED 3000K / CRI ≥ 80**

4050737964164 + 4050737754987
5MN238DLC003 + 5MN91401

LED 3000K / CRI ≥ 80 ϕ_N 4180 lm

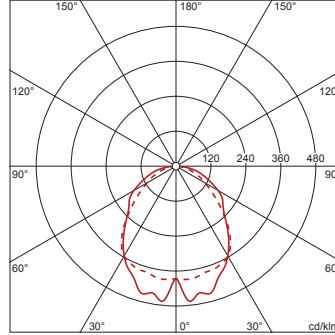

No. of luminaires in room						
Reflection factors 70/50/20						
Em(lx)	100		200		500	
Lh(m)	2.5	3.0	2.5	3.0	2.5	3.0
20 m ²	0.7	0.8	1.4	1.6	3.5	4.0
30 m ²	1.1	1.2	2.1	2.3	5.3	5.8
40 m ²	1.3	1.5	2.7	2.9	6.7	7.3
50 m ²	1.6	1.8	3.2	3.5	8.1	8.8
75 m ²	2.4	2.5	4.7	5.0	12	13
100 m ²	3.1	3.3	6.1	6.5	15	16
500 m ²	14	14	28	29	70	72

Maintenance factor 0.8 Rh = Lh

**5MN238DLC003 + 5MN91402:
1x LED 3000K / CRI ≥ 80**

4050737964164 + 4050737755007
5MN238DLC003 + 5MN91402

LED 3000K / CRI ≥ 80 ϕ_N 4250 lm

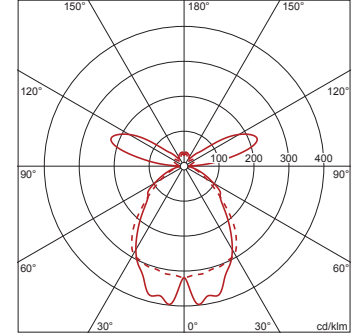

No. of luminaires in room						
Reflection factors 70/50/20						
Em(lx)	100		200		500	
Lh(m)	2.5	3.0	2.5	3.0	2.5	3.0
20 m ²	0.8	0.9	1.6	1.8	4.1	4.6
30 m ²	1.2	1.3	2.4	2.6	6.1	6.6
40 m ²	1.5	1.6	3.0	3.3	7.5	8.2
50 m ²	1.8	2.0	3.6	3.9	9.1	9.8
75 m ²	2.7	2.8	5.4	5.7	14	14
100 m ²	3.5	3.7	6.9	7.3	17	18
500 m ²	15	16	31	32	77	79

Maintenance factor 0.8 Rh = Lh + 0.5 m