

Order No.: 5NY231780KM00 | GTIN (EAN): 4039806382429

Product description: mast,con.rd,steel,galv,8m,Ø76

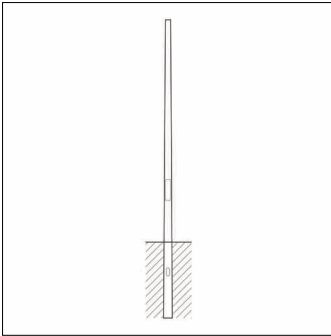

mast, mast, conical round, of steel, galvanised, height: 8.0m, spigot size: 76mm (post-top), planted section: h= 1200mm / Ø= 168mm, standard: DIN EN 40, packaging unit: 1 piece

Wt. (kg): 91.3
GTIN (EAN): 4039806382429

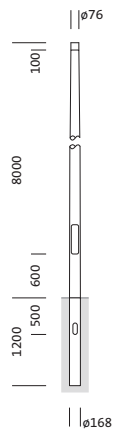

Order No.: 5NY231780KM00 | GTIN (EAN): 4039806382429

Detailed technical description: mast,con.rd,steel,galv,8m,Ø76

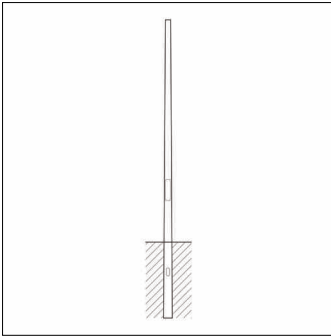

Key data

- Product type: mast
- Product name: mast
- Order No.: 5NY231780KM00

Certificates, Standards

- Standard: DIN EN 40

Material, Colour

- mast: steel, galvanised, conical round

Dimensions, Weight

- Height: 8.0m
- Weight: 91.3kg
- Mast spigot: spigot size: 76mm
- Planted section: h= 1200mm / Ø= 168mm

Order No.: 5NY231780KM00 | GTIN (EAN): 4039806382429

Dimensions: mast,con.rd,steel,galv,8m,Ø76

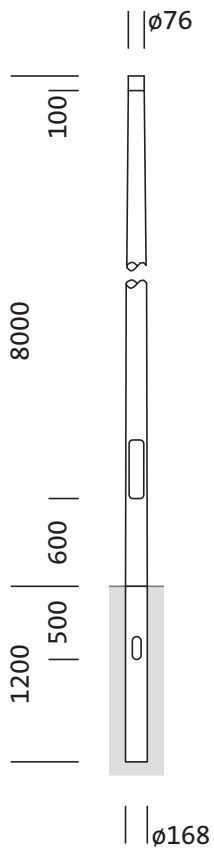

It is mandatory that the assembly instructions must be observed when planning and installing the electrical installation (to be found at www.siteco.de)

Tolerances related to thermal, electrical and photometric data according to IEC 62722

Issued 22.12.2023 - Modifications and errors subject to change - Ensure that you always use the latest version -