

**Order No.:** 5MN238DLC | **GTIN (EAN):** 4050737963761

**Product description:** Vega11,4300lm840,DA

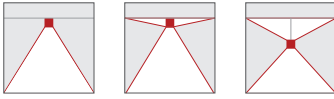

Vega® 11, office luminaire, primary light control with prismatic reflector, of PMMA, transparent prismatic structure, CAT 2 ( $L \leq 1500 \text{cd/m}^2$ ), light emission: direct/indirect distribution, primary light characteristic: symmetric, installation type: suspended mounting, surface-mounted, LED, rated luminous flux: 4.300lm, luminous efficacy: 139lm/W, light colour: 840, colour temperature: 4000K, control gear: ECG, with terminal, 3+2-pole, max. 2.5mm<sup>2</sup>, mains connection: 230V, AC, 50Hz, connection cable inclusive, cable length: 1,5m, rated input power: 31W, luminaire housing, rectangular, rounded, of aluminium section, anodised, metallic grey (RAL 9006), length: 1.250mm, width: 350mm, height: 43mm, luminaire housing, lower part, of aluminium section, anodised, metallic grey (RAL 9006), of PC, grey, protection rating (complete): IP20, insulation class (complete): insulation class I (protective earthing), certification: CE, standard: EN 50419, packaging unit: 1 piece

4050737963761  
5MN238DLC

LED 4000K / CRI  $\geq$  80  $\phi_N$  4300 lm

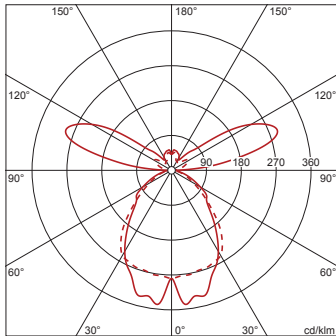

IP 20

Lamps: LED  
Wt. (kg): 6.5  
GTIN (EAN): 4050737963761

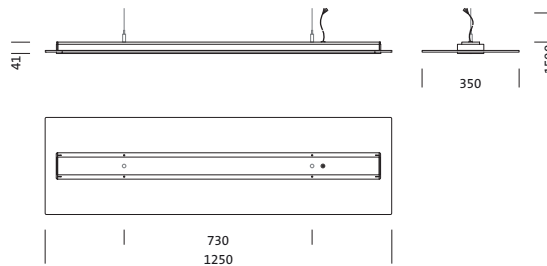

**Order No.:** 5MN238DLC | **GTIN (EAN):** 4050737963761

**Detailed technical description:** Vega11,4300lm840,DA



#### Key data

- Product type: office luminaire
- Product name: Vega® 11
- Order No.: 5MN238DLC

#### Lighting technology | Lamps | Control gear

##### Component 1

#### Lighting technology:

- Light control: prismatic reflector of PMMA, transparent prismatic structure
- Symmetry: symmetric
- Light emission: direct/indirect distribution, 60:40
- UGR viewing direction along longitudinal luminaire axis:  $\leq 16$
- UGR viewing direction along lateral luminaire axis:  $\leq 16$

#### Lamps:

- Lamps: with LED
- Rated luminous flux: 4300lm
- Luminous efficacy: 139lm/W
- Colour temperature: 4000K
- Colour rendering index: CRI > 80
- Light colour: 840
- SDCM (Standard Deviation of Colour Matching): MacAdam  $\leq 3$  SDCM (initial)
- Rated input power: 31W

#### Operating device:

- Control gear: ECG
- Control: DALI

#### Certificates, Standards

- Protection rating: IP20
- Insulation class: insulation class I (protective earthing)
- Standard: EN 50419
- Certification, designation: CE

#### Material, Colour

- luminaire housing: aluminium section, anodised, metallic grey (RAL 9006), rectangular, rounded
- Colour specification: metallic grey (RAL 9006)
- luminaire housing, lower part: aluminium section, anodised, metallic grey (RAL 9006)
- Colour specification: metallic grey (RAL 9006)
- Colour specification: grey

#### Mounting

- Mounting method, mounting location: suspended mounting, surface-mounted
- Arrangement: single arrangement

#### Electrical connection

- Connection: terminal, 3+2-pole, max. 2.5mm<sup>2</sup>
- Nominal voltage: 230V, 220..240V, 50Hz, AC
- Connection cable: inclusive, L= 1.5m

#### Dimensions, Weight

- Length: 1250mm
- Width: 350mm
- Height: 43mm
- Weight: 6.5kg

#### Service life

- Rated service life: 50000h (L80/B50) at AT = 25°C

Order No.: 5MN238DLC | GTIN (EAN): 4050737963761

Dimensions: Vega11,4300lm840,DA

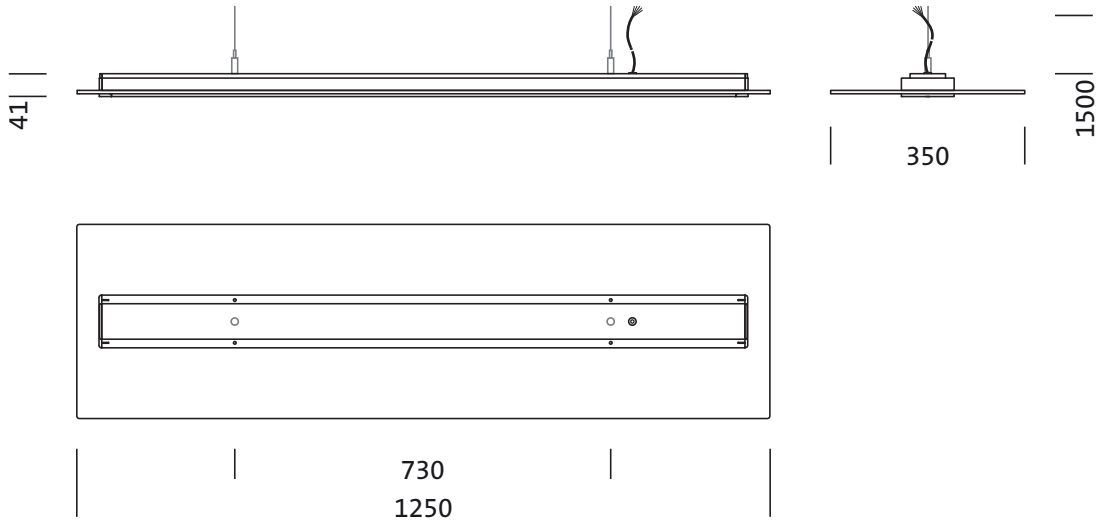

It is mandatory that the assembly instructions must be observed when planning and installing the electrical installation (to be found at [www.siteco.de](http://www.siteco.de))  
Tolerances related to thermal, electrical and photometric data according to IEC 62722  
Issued 08.09.2023 - Modifications and errors subject to change - Ensure that you always use the latest version -

Order No.: 5MN238DLC | GTIN (EAN): 4050737963761

Planning data: Vega1,4300lm840,DA

**5MN238DLC: 1x LED 4000K / CRI ≥ 80**

4050737963761  
5MN238DLC

LED 4000K / CRI ≥ 80  $\phi_N$  4300 lm

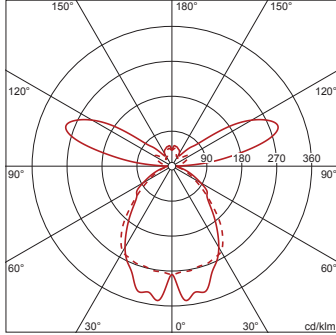

No. of luminaires in room  
Reflection factors 70/50/20

Em(lx)	100		200		500	
	2.5	3.0	2.5	3.0	2.5	3.0
20 m <sup>2</sup>	0.9	1.0	1.7	1.9	4.3	4.8
30 m <sup>2</sup>	1.3	1.4	2.5	2.8	6.4	7.0
40 m <sup>2</sup>	1.6	1.7	3.1	3.4	7.9	8.6
50 m <sup>2</sup>	1.9	2.1	3.8	4.1	9.5	10
75 m <sup>2</sup>	2.8	3.0	5.6	5.9	14	15
100 m <sup>2</sup>	3.6	3.8	7.2	7.6	18	19
500 m <sup>2</sup>	16	16	32	33	80	82

Maintenance factor 0.8

Rh = Lh + 0.5 m

**5MN238DLC + 5MN91401: 1x LED 4000K / CRI ≥ 80**

4050737963761 + 4050737754987  
5MN238DLC + 5MN91401

LED 4000K / CRI ≥ 80  $\phi_N$  4170 lm

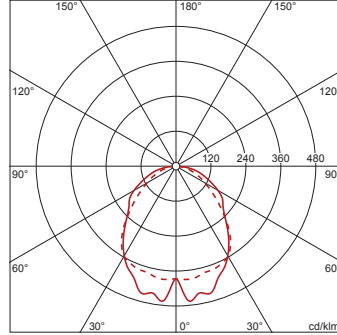

No. of luminaires in room  
Reflection factors 70/50/20

Em(lx)	100		200		500	
	2.5	3.0	2.5	3.0	2.5	3.0
20 m <sup>2</sup>	0.7	0.8	1.4	1.6	3.5	4.1
30 m <sup>2</sup>	1.1	1.2	2.1	2.3	5.3	5.8
40 m <sup>2</sup>	1.3	1.5	2.7	2.9	6.7	7.4
50 m <sup>2</sup>	1.6	1.8	3.2	3.5	8.1	8.8
75 m <sup>2</sup>	2.4	2.5	4.8	5.1	12	13
100 m <sup>2</sup>	3.1	3.3	6.2	6.5	15	16
500 m <sup>2</sup>	14	14	28	29	70	72

Maintenance factor 0.8

Rh = Lh

**5MN238DLC + 5MN91402: 1x LED 4000K / CRI ≥ 80**

4050737963761 + 4050737755007  
5MN238DLC + 5MN91402

LED 4000K / CRI ≥ 80  $\phi_N$  4240 lm

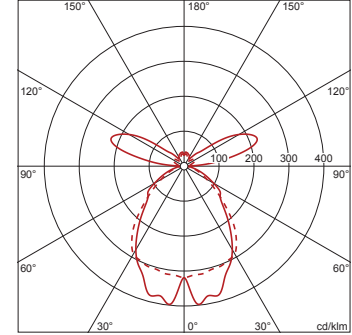

No. of luminaires in room  
Reflection factors 70/50/20

Em(lx)	100		200		500	
	2.5	3.0	2.5	3.0	2.5	3.0
20 m <sup>2</sup>	0.8	0.9	1.6	1.8	4.1	4.6
30 m <sup>2</sup>	1.2	1.3	2.4	2.6	6.1	6.6
40 m <sup>2</sup>	1.5	1.7	3.0	3.3	7.5	8.3
50 m <sup>2</sup>	1.8	2.0	3.6	3.9	9.1	9.9
75 m <sup>2</sup>	2.7	2.8	5.4	5.7	14	14
100 m <sup>2</sup>	3.5	3.7	6.9	7.3	17	18
500 m <sup>2</sup>	15	16	31	32	77	80

Maintenance factor 0.8

Rh = Lh + 0.5 m

It is mandatory that the assembly instructions must be observed when planning and installing the electrical installation (to be found at [www.siteco.de](http://www.siteco.de))

Tolerances related to thermal, electrical and photometric data according to IEC 62722

Issued 08.09.2023 - Modifications and errors subject to change - Ensure that you always use the latest version -