

**Order No.:** 5MN238DLE0S | **GTIN (EAN):** 4050737963747

**Product description:** Vega11,8130lm840,DA,ma

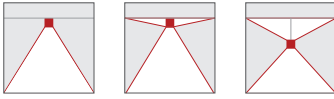

Vega® 11, office luminaire, primary light control with prismatic reflector, of PMMA, transparent prismatic structure, CAT 2 ( $L \leq 1500 \text{cd/m}^2$ ), light emission: direct/indirect distribution, primary light characteristic: symmetric, installation type: suspended mounting, surface-mounted, LED, rated luminous flux: 8.130lm, luminous efficacy: 131lm/W, light colour: 840, colour temperature: 4000K, control gear: ECG, with terminal, 3+2-pole, max. 2.5mm<sup>2</sup>, mains connection: 230V, AC, 50Hz, connection cable inclusive, cable length: 1,5m, rated input power: 62W, luminaire housing, rectangular, rounded, of aluminium section, anodised, metallic grey (RAL 9006), length: 1.250mm, width: 350mm, height: 43mm, luminaire housing, lower part, of aluminium section, anodised, metallic grey (RAL 9006), of PC, grey, protection rating (complete): IP20, insulation class (complete): insulation class I (protective earthing), certification: CE, permissible operating ambient temperature: 0..+35°C, standard: EN 50419, packaging unit: 1 piece

4050737963747  
5MN238DLE0S

LED 4000K / CRI  $\geq$  80  $\Phi_N$  8130 lm

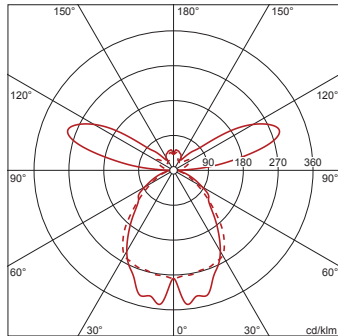

IP 20  

Lamps: LED  
Wt. (kg): 6.6  
GTIN (EAN): 4050737963747

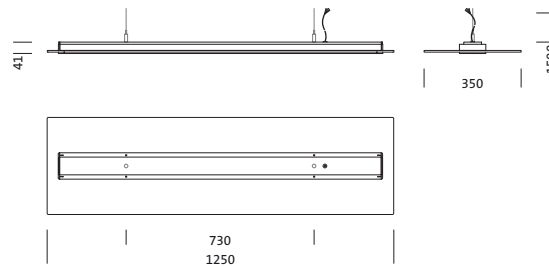

Order No.: 5MN238DLE0S | GTIN (EAN): 4050737963747

Detailed technical description: Vega11,8130lm840,DA,ma



#### Key data

- Product type: office luminaire
- Product name: Vega® 11
- Order No.: 5MN238DLE0S

#### Lighting technology | Lamps | Control gear

#### Component 1

#### Lighting technology:

- Light control: prismatic reflector of PMMA, transparent prismatic structure
- Symmetry: symmetric
- Light emission: direct/indirect distribution, 60:40
- UGR viewing direction along longitudinal luminaire axis:  $\leq 16$
- UGR viewing direction along lateral luminaire axis:  $\leq 16$

#### Lamps:

- Lamps: with LED
- Rated luminous flux: 8130lm
- Luminous efficacy: 131lm/W
- Colour temperature: 4000K
- Colour rendering index: CRI > 80
- Light colour: 840
- SDCM (Standard Deviation of Colour Matching): MacAdam  $\leq 3$  SDCM (initial)
- Rated input power: 62W

#### Operating device:

- Control gear: ECG
- Control: DALI

#### Certificates, Standards

- Protection rating: IP20
- Insulation class: insulation class I (protective earthing)
- Temperature range (operation): 0..+35°C
- Standard: EN 50419
- Certification, designation: CE

#### Material, Colour

- luminaire housing: aluminium section, anodised, metallic grey (RAL 9006), rectangular, rounded
- Colour specification: metallic grey (RAL 9006)
- luminaire housing, lower part: aluminium section, anodised, metallic grey (RAL 9006)
- Colour specification: metallic grey (RAL 9006)
- Colour specification: grey

#### Mounting

- Mounting method, mounting location: suspended mounting, surface-mounted
- Mounting height: 2..4m
- Arrangement: single arrangement

#### Electrical connection

- Connection: terminal, 3+2-pole, max. 2.5mm<sup>2</sup>
- Nominal voltage: 230V, 220..240V, 50Hz, AC
- Connection cable: inclusive, L= 1.5m

#### Dimensions, Weight

- Length: 1250mm
- Width: 350mm
- Height: 43mm
- Weight: 6.6kg

#### Service life

- Rated service life: 50000h (L80/B50) at AT = 25°C

#### Outputs

#### 1x DALI

- Feature: DALI, master function, broadcast addressing, max. 32 DALI ECGs

Order No.: 5MN238DLE0S | GTIN (EAN): 4050737963747

Dimensions: Vega11,8130lm840,DA,ma

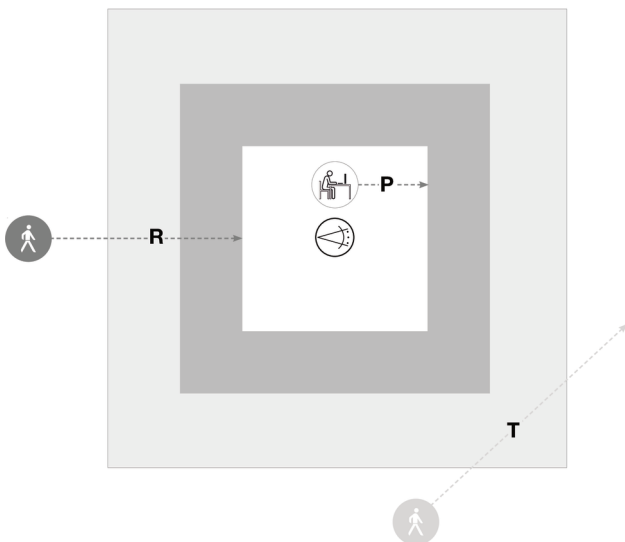
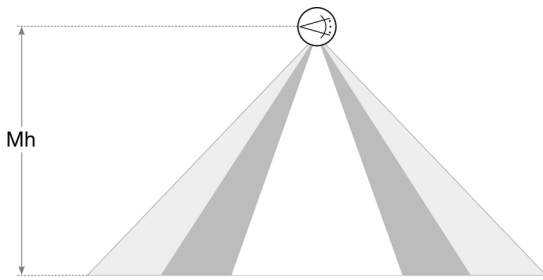
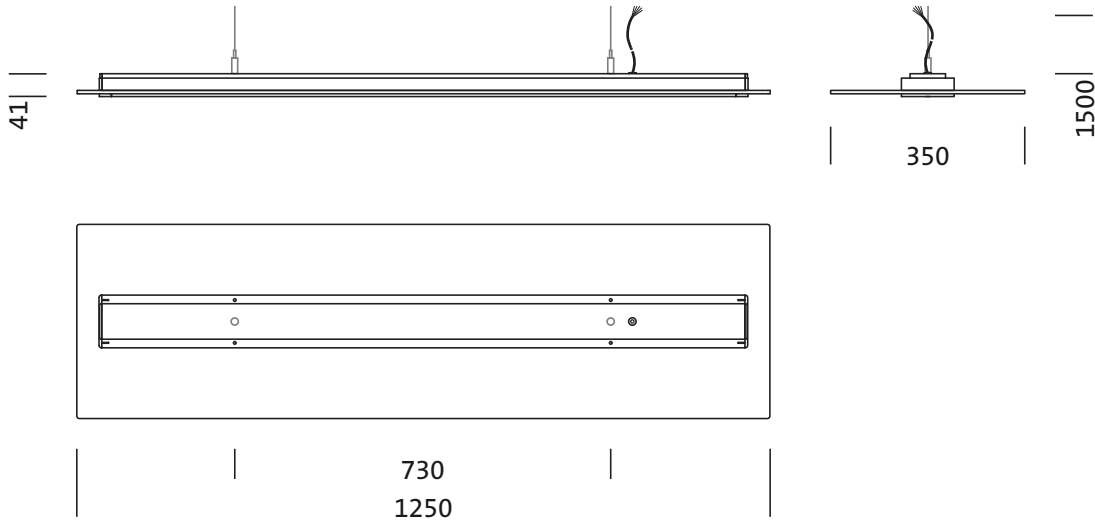

### Sensor PR3

Mh	R	T	P
2,5m	ca. 3x3m	ca. 4x5m	ca. 2x2m
3,5m	ca. 4x4m	ca. 5x6m	ca. 3x3m

It is mandatory that the assembly instructions must be observed when planning and installing the electrical installation (to be found at [www.siteco.de](http://www.siteco.de))  
 Tolerances related to thermal, electrical and photometric data according to IEC 62722  
 Issued 08.09.2023 - Modifications and errors subject to change - Ensure that you always use the latest version -

Order No.: 5MN238DLE0S | GTIN (EAN): 4050737963747

Planning data: Vega11,8130lm840,DA,ma

**5MN238DLE0S: 1x LED**  
4000K / CRI ≥ 80

4050737963747  
5MN238DLE0S  
LED 4000K / CRI ≥ 80  $\phi_N$  8130 lm

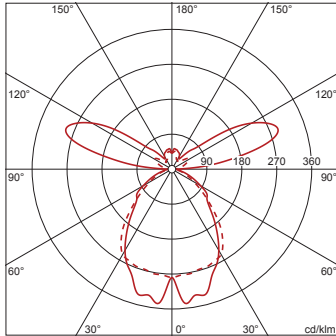

No. of luminaires in room						
Reflection factors 70/50/20						
Em(lx)	100		200		500	
Lh(m)	2.5	3.0	2.5	3.0	2.5	3.0
20 m <sup>2</sup>	0.5	0.5	0.9	1.0	2.3	2.6
30 m <sup>2</sup>	0.7	0.7	1.3	1.5	3.4	3.7
40 m <sup>2</sup>	0.8	0.9	1.7	1.8	4.2	4.6
50 m <sup>2</sup>	1.0	1.1	2.0	2.2	5.0	5.4
75 m <sup>2</sup>	1.5	1.6	3.0	3.1	7.4	7.8
100 m <sup>2</sup>	1.9	2.0	3.8	4.0	9.5	10
500 m <sup>2</sup>	8.4	8.7	17	17	42	43

Maintenance factor 0.8 Rh = Lh + 0.5 m

**5MN238DLE0S + 5MN91401:**  
1x LED 4000K / CRI ≥ 80

4050737963747 + 4050737754987  
5MN238DLE0S + 5MN91401  
LED 4000K / CRI ≥ 80  $\phi_N$  7910 lm

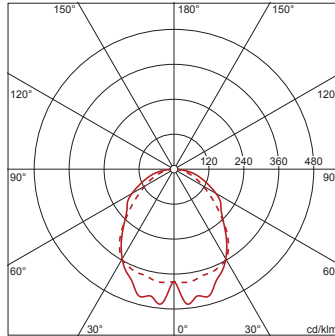

No. of luminaires in room						
Reflection factors 70/50/20						
Em(lx)	100		200		500	
Lh(m)	2.5	3.0	2.5	3.0	2.5	3.0
20 m <sup>2</sup>	0.4	0.4	0.7	0.9	1.9	2.1
30 m <sup>2</sup>	0.6	0.6	1.1	1.2	2.8	3.1
40 m <sup>2</sup>	0.7	0.8	1.4	1.6	3.5	3.9
50 m <sup>2</sup>	0.9	0.9	1.7	1.9	4.3	4.6
75 m <sup>2</sup>	1.3	1.3	2.5	2.7	6.3	6.7
100 m <sup>2</sup>	1.6	1.7	3.2	3.4	8.1	8.6
500 m <sup>2</sup>	7.4	7.6	15	15	37	38

Maintenance factor 0.8 Rh = Lh

**5MN238DLE0S + 5MN91402:**  
1x LED 4000K / CRI ≥ 80

4050737963747 + 4050737755007  
5MN238DLE0S + 5MN91402  
LED 4000K / CRI ≥ 80  $\phi_N$  8030 lm

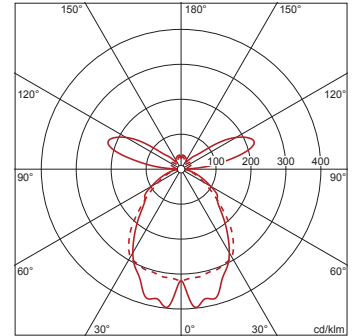

No. of luminaires in room						
Reflection factors 70/50/20						
Em(lx)	100		200		500	
Lh(m)	2.5	3.0	2.5	3.0	2.5	3.0
20 m <sup>2</sup>	0.4	0.5	0.9	1.0	2.1	2.4
30 m <sup>2</sup>	0.6	0.7	1.3	1.4	3.2	3.5
40 m <sup>2</sup>	0.8	0.9	1.6	1.7	4.0	4.4
50 m <sup>2</sup>	1.0	1.0	1.9	2.1	4.8	5.2
75 m <sup>2</sup>	1.4	1.5	2.9	3.0	7.2	7.5
100 m <sup>2</sup>	1.8	1.9	3.7	3.9	9.2	9.7
500 m <sup>2</sup>	8.2	8.4	16	17	41	42

Maintenance factor 0.8 Rh = Lh + 0.5 m