

Order No.: 5XA7571B1K23 | GTIN (EAN): 4058352624586

Product description: SiC31mn,PL32,8000lm730,0/1



SiCompact® 31 mini, floodlight, primary light control with lens, of plastic, of toughened safety glass, transparent, light distribution: PL32, light emission: direct distribution, primary light characteristic: asymmetric, installation type: surface-mounted, LED, High Power LED, rated luminous flux: 8.000lm, luminous efficacy: 167lm/W, light colour: 730, colour temperature: 3000K, control gear: ECG, with cable, 3x 1.5mm², mains connection: 220..240V, AC, 50/60Hz, connection cable pre-assembled, cable length: 2m, rated input power: 48W, of diecast aluminium, specular, metallic grey (RAL 9006), length: 461 mm, width: 261mm, height: 62mm, bracket, of sheet steel, coated, metallic grey (RAL 9006), ON/OFF, protection rating (complete): IP66, insulation class (complete): insulation class I (protective earthing), certification: CE, ENEC, impact resistance: IK08, permissible operating ambient temperature: -40..+45°C, packaging unit: 1 piece



Lamps:	LED
Wt. (kg):	5.8
GTIN (EAN):	4058352624586

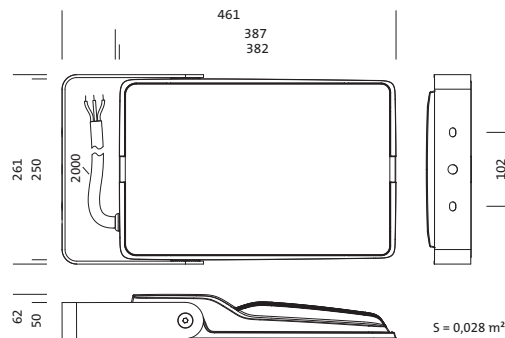

Order No.: 5XA7571B1K23 | GTIN (EAN): 4058352624586

Detailed technical description: SiC31mn,PL32,8000lm730,0/1



Key data

- Product type: floodlight
- Product name: SiCompact® 31 mini
- Order No.: 5XA7571B1K23

Lighting technology | Lamps | Control gear

Component 1

Lighting technology:

- Light control: lens of plastic
- Light distribution: PL32
- Symmetry: asymmetric distribution
- Light emission: direct distribution

Lamps:

- Lamps: with High Power LED, LED
- Rated luminous flux: 8000lm
- Luminous efficacy: 167lm/W
- Colour temperature: 3000K
- Colour rendering index: CRI > 70
- Light colour: 730
- Rated input power: 48W

Operating device:

- Control gear: ECG
- Control: ON/OFF

Certificates, Standards

- Protection rating: IP66
- Insulation class: insulation class I (protective earthing)
- Impact resistance: IK08
- Temperature range (operation): -40..+45°C
- Certification, designation: CE, ENEC

Material, Colour

- Colour specification: metallic grey (RAL 9006)
- bracket: sheet steel, coated, metallic grey (RAL 9006)
- Colour specification: metallic grey (RAL 9006)

Mounting

- Mounting method, mounting location: surface-mounted, to supporting structure, to the cross arm, to the wall
- Arrangement: single arrangement
- Supplement: with mounting bracket

Electrical connection

- Connection: cable, 3x 1.5mm²
- Nominal voltage: 220..240V, 50/60Hz, AC
- Surge voltage resistance: 10kV 1.2/50µs
- Connection cable: pre-assembled, L= 2m

Dimensions, Weight

- Length: 461mm
- Width: 261mm
- Height: 62mm
- Weight: 5.8kg

Light emission

- Light emission: 0% at 0° inclination

Service life

- Rated service life: 73000h (L80/B50) at AT = 25°C

Order No.: 5XA7571B1K23 | GTIN (EAN): 4058352624586

Dimensions: SiC31mn,PL32,8000lm730,0/1

