

Order No.: 5XA7772B2A1A | GTIN (EAN): 4058352632154

Product description: FL21iQmn,PL43,6400lm730,SR,bracket



Floodlight FL 21 iQ mini, floodlight, primary light control with lens, of PMMA, primary optical cover: protective disc, of toughened safety glass, transparent, light distribution: PL43, light emission: direct distribution, installation type: surface-mounted, LED, High Power LED, rated luminous flux: 6.400lm, luminous efficacy: 141lm/W, light colour: 730, colour temperature: 3000K, control: Street-Remote, Auto-Match, Temp-Guard, Night-Set, Smart-Wire, Desk-Remote (wireless, voltage-free reading and setting of iQ features in the workshop via application-optimized NFC function/RFID function), optimised constant luminous flux control (CLO 2.0), with terminal, 6-pole, mains connection: 220..240V, AC, 50/60Hz, start of lifetime: 46W, end of service life: 48W, reduction: 22W, luminaire housing, of diecast aluminium, powder-coated, Siteco® metallic grey (DB 702S), corrosivity category C5 mid according to DIN EN ISO 12944, sealing non-destructively replaceable, mounting bracket, of steel, galvanised, powder-coated, Siteco® metallic grey (DB 702S), protection rating (complete): IP66, insulation class (complete): insulation class II (safety insulation), certification: CE, ENEC, VDE, protection symbol: D, impact resistance: IK08, permissible operating ambient temperature: -40..+40°C, permissible operating ambient temperature for outdoor applications: -40..+50°C, standard: DIN EN 12944, LABS conformity tested according to VDMA 24364:2018-05, packaging unit: 1 piece



Lamps:	LED
Wt. (kg):	7.2
GTIN (EAN):	4058352632154



Order No.: 5XA7772B2A1A | GTIN (EAN): 4058352632154

Detailed technical description: FL21iQmn,PL43,6400lm730,SR,bracket



### Key data

- Product type: floodlight
- Product name: Floodlight FL 21 iQ mini
- Order No.: 5XA7772B2A1A

### Lighting technology | Lamps | Control gear

#### Component 1

#### Lighting technology:

- Light control: lens of PMMA
- Cover: protective disc, transparent
- Light distribution: PL43
- Light emission: direct distribution

#### Lamps:

- Lamps: with High Power LED, LED
- Rated luminous flux: 6400lm
- Luminous efficacy: 141lm/W
- Colour temperature: 3000K
- Colour rendering index: CRI > 70
- Light colour: 730
- Rated input power begin service life: 46
- Rated input power end service life: 48
- Rated input power at 50% lumin. flux: 22
- Supplement: prepared for through-wiring

#### Operating device:

- Control: iQ Street-Remote
- Equipment: optimised constant luminous flux control (CLO 2.0), Desk-Remote (wireless, voltage-free reading and setting of iQ features in the workshop via application-optimized NFC function/RFID function), Smart-Wire, Night-Set, Temp-Guard, Auto-Match, Street-Remote

### Certificates, Standards

- Protection rating: IP66
- Insulation class: insulation class II (safety insulation)
- Impact resistance: IK08
- Protection symbol: D
- Temperature range (operation): -40..+40°C
- Supplement: LABS conformity tested according to VDMA 24364:2018-05
- Standard: DIN EN 12944
- Corrosion protection: corrosivity category C5 mid according to DIN EN ISO 12944
- Certification, designation: CE, ENEC, VDE

### Material, Colour

- luminaire housing: diecast aluminium, powder-coated, Siteco® metallic grey (DB 702S), sealing non-destructively replaceable
- Colour specification: Siteco® metallic grey (DB 702S)
- mounting bracket: steel, galvanised, powder-coated, Siteco® metallic grey (DB 702S)
- Colour specification: Siteco® metallic grey (DB 702S)
- Cover: protective disc of toughened safety glass

### Mounting

- Mounting method, mounting location: surface-mounted, to mast, to supporting structure, to the cross arm
- Arrangement: single arrangement
- Supplement: with mounting bracket

### Electrical connection

- Connection: terminal, 6-pole
- Nominal voltage: 220..240V, 50/60Hz, AC
- Surge voltage resistance: surge voltage resistance: 10kV (common mode); 6kV (differential mode)

### Dimensions, Weight

- Weight: 7.2kg

### Service life

- Rated service life: 100000h (L97/B10) at AT = 25°C

Order No.: 5XA7772B2A1A | GTIN (EAN): 4058352632154

Dimensions: FL21iQmn,PL43,6400lm730,SR,bracket

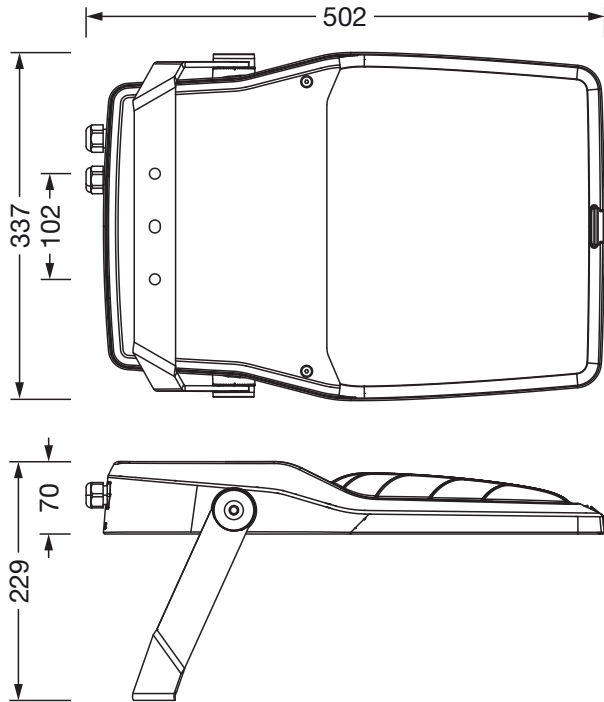

It is mandatory that the assembly instructions must be observed when planning and installing the electrical installation (to be found at [www.siteco.de](http://www.siteco.de))  
Tolerances related to thermal, electrical and photometric data according to IEC 62722  
Issued 13.04.2024 - Modifications and errors subject to change - Ensure that you always use the latest version -