

Order No.: 5XMOD0165L | **GTIN (EAN):** 4058352780572

Product description: SL10mc,LEDmod,P1.0a,727

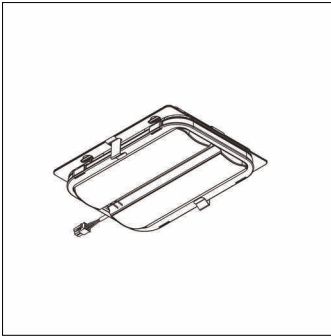

Streetlight 10 micro, LED module, primary light control with cycle path optic, light distribution: P1.0a, primary light characteristic: asymmetric, High Power LED, light colour: 727, colour temperature: 2700K, mains connection: 230..240V, 50Hz, LED module, length: 174mm, width: 137mm, height: 40mm, protection rating (complete): as luminaire, packaging unit: 1 piece

Wt. (kg): 0.8
GTIN (EAN): 4058352780572

Order No.: 5XMOD0165L | GTIN (EAN): 4058352780572

Detailed technical description: SL10mc,LEDmod,P1.0a,727

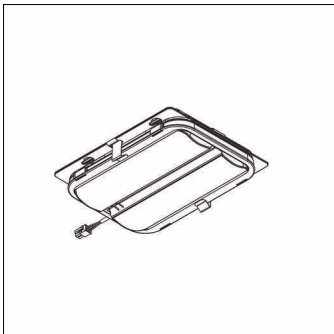

Key data

- Product type: LED module
- Product name: Streetlight 10 micro
- Order No.: 5XMOD0165L

Lighting technology | Lamps | Control gear

Component 1

Lighting technology:

- Light control: cycle path optic
- Light distribution: P1.0a
- Beam angle: extremely wide distribution
- Symmetry: asymmetric distribution

Lamps:

- Lamps: with High Power LED
- Colour temperature: 2700K
- Colour rendering index: CRI > 70
- Light colour: 727
- Supplement: power consumption when used in Streetlight 10 Plus luminaires: construction size micro 8.5..11.5W

Certificates, Standards

- Protection rating: as luminaire

Electrical connection

- Nominal voltage: 230..240V, 50Hz

Dimensions, Weight

- Length: 174mm
- Width: 137mm
- Height: 40mm
- Weight: 0.8kg