

**Order No.:** 5XMOD0155K | **GTIN (EAN):** 4058352780510

**Product description:** SL10mc,LEDmod,ST1.2a,730

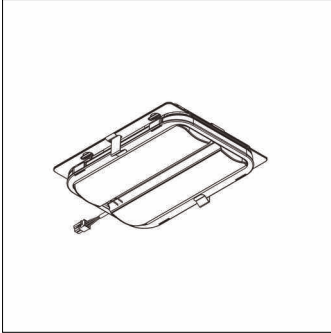

Streetlight 10 micro, LED module, light distribution: ST1.2a, primary light characteristic: asymmetric, High Power LED, light colour: 730, colour temperature: 3000K, mains connection: 230..240V, 50Hz, LED module, length: 174mm, width: 137mm, height: 40mm, protection rating (complete): as luminaire, packaging unit: 1 piece

Wt. (kg): 0.8  
GTIN (EAN): 4058352780510

Order No.: 5XMOD0155K | GTIN (EAN): 4058352780510

Detailed technical description: SL10mc,LEDmod,ST1.2a,730

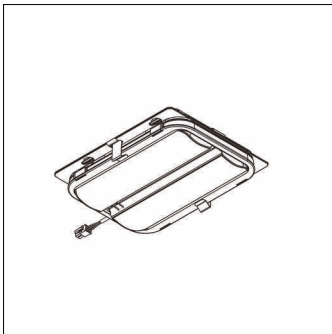

#### Key data

- Product type: LED module
- Product name: Streetlight 10 micro
- Order No.: 5XMOD0155K

#### Lighting technology | Lamps | Control gear

##### Component 1

#### Lighting technology:

- Light distribution: ST1.2a
- Beam angle: wide distribution
- Symmetry: asymmetric distribution

#### Lamps:

- Lamps: with High Power LED
- Colour temperature: 3000K
- Colour rendering index: CRI > 70
- Light colour: 730
- Supplement: power consumption when used in Streetlight 10 Plus luminaires: construction size micro 8.5..11.5W

#### Certificates, Standards

- Protection rating: as luminaire

#### Electrical connection

- Nominal voltage: 230..240V, 50Hz

#### Dimensions, Weight

- Length: 174mm
- Width: 137mm
- Height: 40mm
- Weight: 0.8kg