

Order No.: 51FT10MN4A0ATR1 | **GTIN (EAN):** 4058352742136

Product description: Mon31T,diff,10000lm840,ML,PMMA



Monsun® 31 Tube, tubular luminaire, primary optical cover: diffuser, of PMMA, light emission: direct distribution, primary light characteristic: symmetric, LED, rated luminous flux: 10.000lm, luminous efficacy: 172lm/W, light colour: 840, colour temperature: 4000K, with with 1 terminal, 3-pole, max. 2.5mm², mains connection: 220..240V, AC, 50/60Hz, rated input power: 58W, housing, cylindrical, of PMMA, semi-transparent, matt white, with luminaire and ceiling fastening, V4A, mounting with brackets of stainless steel, length: 1.495mm, diameter: 75mm, end cap, of stainless steel (V4A), protection rating (complete): IP20, protection rating (lamp compartment): IP67/69K, insulation class (complete): insulation class I (protective earthing), certification: CE, UKCA, impact resistance: IK07, permissible operating ambient temperature: -20..+40°C, corresponds to IFS (International Featured Standards) requirements for safety and quality in the food industry, contact your sales advisor before using the luminaires in applications with unclear chemical exposure, large temperature fluctuations or condensation-forming humidity, packaging unit: 1 piece

IP 20 IK 07   

Lamps:	LED
Wt. (kg):	2.6
GTIN (EAN):	4058352742136

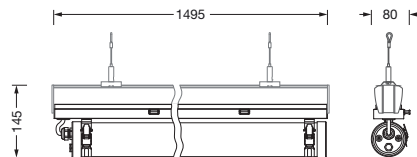

Order No.: 51FT10MN4A0ATR1 | **GTIN (EAN):** 4058352742136

Detailed technical description: Mon31T,diff,10000lm840,ML,PMMA



Key data

- Product type: tubular luminaire
- Product name: Monsun® 31 Tube
- Order No.: 51FT10MN4A0ATR1

Lighting technology | Lamps | Control gear

Component 1

Lighting technology:

- Cover: diffuser
- Beam angle: diffuse distribution
- Symmetry: symmetric
- Light emission: direct distribution
- UGR viewing direction along longitudinal luminaire axis: ≤ 25
- UGR viewing direction along lateral luminaire axis: ≤ 25

Lamps:

- Lamps: with LED
- Rated luminous flux: 10000lm
- Luminous efficacy: 172lm/W
- Colour temperature: 4000K
- Colour rendering index: CRI > 80
- Light colour: 840
- SDCM (Standard Deviation of Colour Matching): MacAdam ≤ 4 SDCM (initial)
- Rated input power: 58W
- Supplement: connected load according to luminous flux setting (25/37/46/58W), luminous flux adjustable on luminaire in four steps (4450/6500/8000/10000lm)

Operating device:

- Control: ON/OFF Multilumen

Certificates, Standards

- Protection rating: IP20
- Protection rating (lamp compartment): IP67/69K
- Insulation class: insulation class I (protective earthing)
- Impact resistance: IK07
- Temperature range (operation): -20..+40°C
- Supplement: corresponds to IFS (International Featured Standards) requirements for safety and quality in the food industry, contact your sales advisor before using the luminaires in applications with unclear chemical exposure, large temperature fluctuations or condensation-forming humidity
- Certification, designation: CE, UKCA

Material, Colour

- housing: PMMA, semi-transparent, matt white, cylindrical, with luminaire and ceiling fastening, V4A, mounting with brackets of stainless steel
- Colour specification: matt white
- end cap: stainless steel (V4A)
- Quantity: 2 piece
- Cover: diffuser of PMMA

Mounting

- Arrangement: single arrangement

Electrical connection

- Connection: with 1 terminal, 3-pole, max. 2.5mm²
- Nominal voltage: 220..240V, 50/60Hz, AC

Dimensions, Weight

- Length: 1495mm
- Diameter: 75mm
- Weight: 2.6kg

Service life

- Rated service life: 50000h (L80/B50) at AT = 25°C

Order No.: 51FT10MN4A0ATR1 | GTIN (EAN): 4058352742136

Dimensions: Mon31T,diff,10000lm840,ML,PMMA

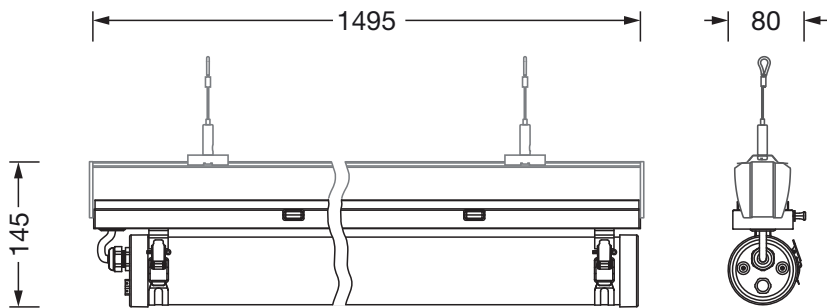

It is mandatory that the assembly instructions must be observed when planning and installing the electrical installation (to be found at www.siteco.de)
Tolerances related to thermal, electrical and photometric data according to IEC 62722
Issued 10.11.2023 - Modifications and errors subject to change - Ensure that you always use the latest version -