

Order No.: 5XA8571A1121 | GTIN (EAN): 4058352718377

Product description: FL41mn,PL32,13000lm730,ML



Floodlight FL 41 mini, floodlight, primary light control with lens, of PMMA, primary optical cover: protective disc, transparent, light distribution: PL32, light emission: direct distribution, installation type: surface-mounted, LED, High Power LED, rated luminous flux: 13.000lm, luminous efficacy: 130lm/W, light colour: 730, colour temperature: 3000K, with cable, 3x 1.5mm<sup>2</sup>, mains connection: 220..240V, AC, 50/60Hz, connection cable pre-assembled, cable length: 2m, rated input power: 100W, luminaire housing, of diecast aluminium, powder-coated, metallic grey (RAL 9006), length: 265mm, width: 245mm, height: 54mm, protection rating (complete): IP65, insulation class (complete): insulation class I (protective earthing), certification: CE, impact resistance: IK08, permissible operating ambient temperature: -40..+40°C, permissible storage temperature: -40..+60°C, packaging unit: 1 piece

IP 65 IK 08  

Lamps:	LED
Wt. (kg):	2.1
GTIN (EAN):	4058352718377

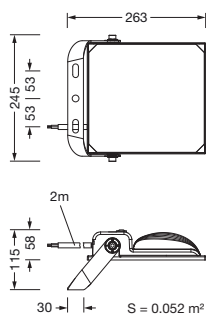

It is mandatory that the assembly instructions must be observed when planning and installing the electrical installation (to be found at [www.siteco.de](http://www.siteco.de))  
Tolerances related to thermal, electrical and photometric data according to IEC 62722  
Issued 11.08.2023 - Modifications and errors subject to change - Ensure that you always use the latest version -

Order No.: 5XA8571A1121 | GTIN (EAN): 4058352718377

Detailed technical description: FL41mn,PL32,13000lm730,ML



#### Key data

- Product type: floodlight
- Product name: Floodlight FL 41 mini
- Order No.: 5XA8571A1121

#### Lighting technology | Lamps | Control gear

#### Component 1

#### Lighting technology:

- Light control: lens of PMMA
- Cover: protective disc, transparent
- Light distribution: PL32
- Light emission: direct distribution

#### Lamps:

- Lamps: with High Power LED, LED
- Rated luminous flux: 13000lm
- Luminous efficacy: 130lm/W
- Colour temperature: 3000K
- Colour rendering index: CRI > 70
- Light colour: 730
- SDCM (Standard Deviation of Colour Matching): MacAdam  $\leq$  7 SDCM (initial)
- Rated input power: 100W
- Supplement: luminous flux adjustable on luminaire in four steps (3900/6500/9100/13000lm), connected load according to luminous flux setting (30/50/70/100W)

#### Operating device:

- Control: ON/OFF Multilumen

#### Certificates, Standards

- Protection rating: IP65
- Insulation class: insulation class I (protective earthing)
- Impact resistance: IK08
- Temperature range (operation): -40..+40°C
- Certification, designation: CE

#### Material, Colour

- luminaire housing: diecast aluminium, powder-coated, metallic grey (RAL 9006)
- Colour specification: metallic grey (RAL 9006)
- Cover: protective disc

#### Mounting

- Mounting method, mounting location: surface-mounted
- Arrangement: single arrangement
- Supplement: with mounting bracket

#### Electrical connection

- Connection: cable, 3x 1.5mm<sup>2</sup>
- Nominal voltage: 220..240V, 50/60Hz, AC
- Connection cable: pre-assembled, L= 2m

#### Dimensions, Weight

- Length: 265mm
- Width: 245mm
- Height: 54mm
- Weight: 2.1kg

#### Service life

- Rated service life: 50000h (L80/B50) at AT = 25°C

Order No.: 5XA8571A1121 | GTIN (EAN): 4058352718377

Dimensions: FL41mn,PL32,13000lm730,ML

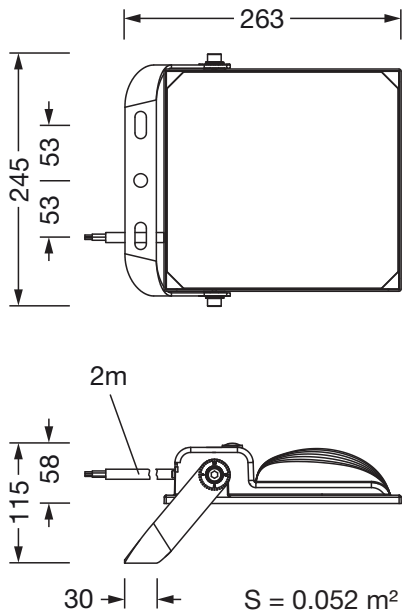

It is mandatory that the assembly instructions must be observed when planning and installing the electrical installation (to be found at [www.siteco.de](http://www.siteco.de))

Tolerances related to thermal, electrical and photometric data according to IEC 62722

Issued 11.08.2023 - Modifications and errors subject to change - Ensure that you always use the latest version -