

Order No.: 5XMOD1115M | **GTIN (EAN):** 4058352690284

Product description: SL10mnmd,LEDmod,PCL,740

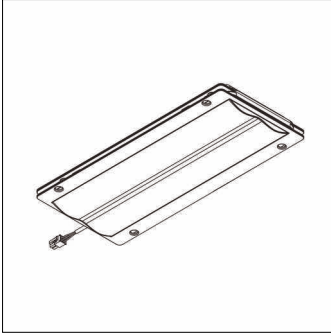

Streetlight 10 mini/midi, LED module, primary light control with pedestrian crossing, asymmetric left distribution, light distribution: PC-L, High Power LED, light colour: 740, colour temperature: 4000K, mains connection: 230..240V, 50Hz, LED module, length: 310mm, width: 137mm, height: 40mm, protection rating (complete): as luminaire, packaging unit: 1 piece

Wt. (kg): 1.2
GTIN (EAN): 4058352690284

Order No.: 5XMOD1115M | GTIN (EAN): 4058352690284

Detailed technical description: SL10mnmd,LEDmod,PCL,740



Key data

- Product type: LED module
- Product name: Streetlight 10 mini/midi
- Order No.: 5XMOD1115M

Lighting technology | Lamps | Control gear

Component 1

Lighting technology:

- Light control: pedestrian crossing, asymmetric left distribution
- Light distribution: PC-L

Lamps:

- Lamps: with High Power LED
- Colour temperature: 4000K
- Colour rendering index: CRI > 70
- Light colour: 740
- Supplement: power consumption when used in Streetlight 10 Plus luminaires:
construction size mini 16.2..22.8W,
construction size midi 45.1..63.6W

Certificates, Standards

- Protection rating: as luminaire

Electrical connection

- Nominal voltage: 230..240V, 50Hz

Dimensions, Weight

- Length: 310mm
- Width: 137mm
- Height: 40mm
- Weight: 1.2kg